

Suppression modules for inductive products simplify the fulfilment of the EMC law!

Old laws have not lost their validity now. The Ohm's law is still valid everywhere, as well as the Lenz's rule. This states that when an inductive load is switched off, current has the desire to continue flowing in the same direction and strength as before. A voltage source is created from the inductive load, which can be many times higher than the nominal voltage. This voltage spike is the cause of many EMC problems.

What does the EMC law achieve?

From the 1st January 1996 only products which fulfil the requirements of § 4 of the EMC guidelines, can be brought into the European market.

That means:

Products cannot send out interference nor be influenced by it. Suppression components do not fall under the EMC guidelines.

Reasons for interferences

1. High inductive voltage spikes at inductive loads:

The high voltage spikes when switching off exceed the normal supply voltage many times and overload the electronics. The voltage can in some cases be so high, that the windings are shorted and the inductive product is destroyed.

2. High inductive voltage spikes in the automated system:

The voltage spikes climb at a very high speed. These very high climb rates contain high frequencies. Every cable and wire in the control system acts as a transmitter or receiver for these high frequencies.

These high frequency interferences can therefore move unhindered from cable to neighboring cable.

3. High inductive voltage spikes in the controller:

The present voltage spike at the moment of switching off adds itself in opposite polarity to the supply voltage and affects the controller i.e. PLC.

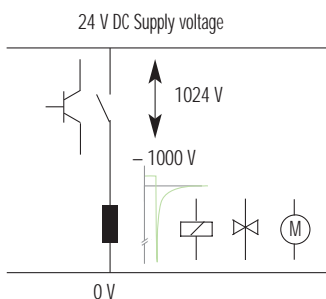

These high voltages in the controller cause energy rich arcs, due to the current flowing on in the same strength and direction at the moment that the contact is opened. The arcs cause material deformation and reduce the life expectancy of the switching elements.

Murrelektronik solves your interference problems:

- faults in the control process
- defective control system
- defective coil on the motor, contactor, valve or transformer
- interference emissions causing a reduction in functionality
- EMC problems

Suppression modules for control systems

Murrelektronik supply suppressors for all standard inductive users.

For contactors

- Integrated system solutions for all common protectors.
- Contactors or relays for universal suppressors can be snapped onto DIN-rail.

For motors

- Direct suppression inside the motor terminal box.
- Motor connection socket 10 + E with integrated suppression and manufactured cable.
- Integrated system solutions for direct mounting.
- The universal suppressors should be mounted very close to the source of interference (motor).

For valves

- Easy mounting of suppressor.

Advantage:

- Optimum interference through individual adaption.
- Easy mounting through prefabricated modules – always the perfect solution.
- Less breakdowns increase availability and reduces downtime.
- High life span of contacts and control units reduces maintenance cost.

An overview of different types of suppressors

Circuit	Characteristics of load current and voltage	Incorrect polarity protection and also suitable for AC	Additional switch-off delay	Back e. m. f. limitation	Damping also occurs below U_{limit}	Components
		no	very large	1 V	no	Advantages: <ul style="list-style-type: none"> • matches wide range of loads • best possible damping • simple construction Disadvantages: <ul style="list-style-type: none"> • long delay time
		yes	small	U_{VDR}	yes	Advantages: <ul style="list-style-type: none"> • HF-damping due to RC-network • high energy absorption • short delay time Disadvantages: <ul style="list-style-type: none"> • must be matched to the load • limited lifespan
		yes	small	U_{ZD}	no	Advantages: <ul style="list-style-type: none"> • limits positive and negative voltages • suitable for AC and DC • matches wide range of loads Disadvantages: <ul style="list-style-type: none"> • no damping below U_{ZD}
		yes	small	U_{VDR}	no	Advantages: <ul style="list-style-type: none"> • matches wide range of loads • high energy absorption • very simple construction Disadvantages: <ul style="list-style-type: none"> • no damping below U_{VDR} • limited lifespan
		yes	small	$1,5 \times U_{\text{NOM}}$	yes	Advantages: <ul style="list-style-type: none"> • HF-damping due to RC-network • immediate de-energization • excellent results with AC Disadvantages: <ul style="list-style-type: none"> • must be matched to the load • limited lifespan

EMC suppressors for contactors

For all common manufacturers with integrated system solution.



To combat high voltage switch off overloads, which lead to contact burn out and destruction of the neighboring electronic control systems, contactors should be suppressed.

Murrelektronik has for years developed and produced suppression modules, which are carefully designed together with the contactor manufactures, to work with specific contactors.

The mechanical mounting of the modules is therefore exact and simple as well as guaranteeing the optimum suppression characteristics.

Connection is via flexible wires or direct contacts.

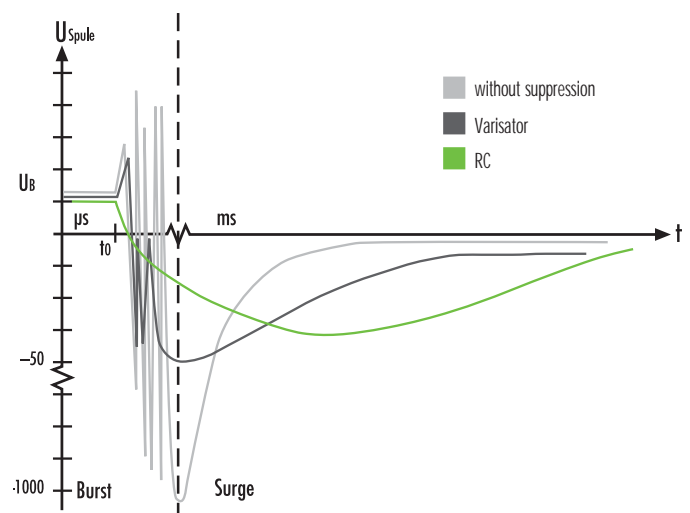

Standardized motor suppression from Murrelektronik

We offer a suitable motor suppressor for every application. The suppressor should, if at all possible be mounted very close to the source of interference (motor). The European norm (EN 50262) has been valid since 31st December 1999 for metric threads and replaces the DIN 46320 for PG threads. There are also modules available which can be snapped onto DIN-rail.

The use of motor suppression equipment protects the motor from high inductive voltage spikes when switching off. At the same time, it increases the contact life span of the control unit. With the optimum suppression modules from Murrelektronik, you receive the highest level of operational safety.

The machine or control panel will function within the EMC regulations, without affecting other electrical equipment in the surrounding area.

Suppression at the motor terminal box

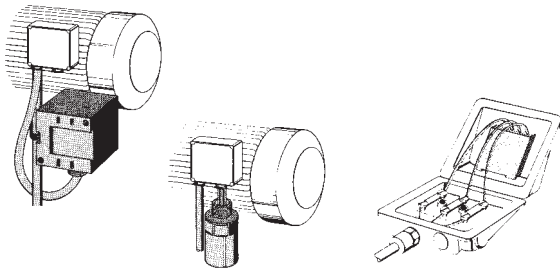

Suppression, where the interference arises !

Mounts directly on the motor

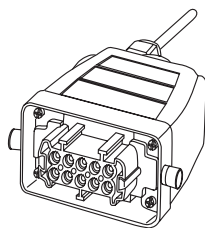

“Plugged in what else.”

Snap-on under the contactor

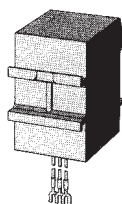

Space savings.

Suppression modules for valves

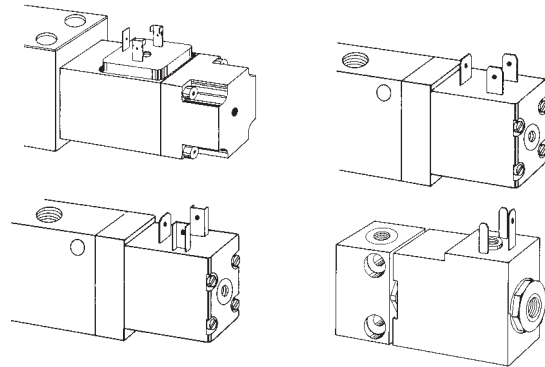

For every form a suitable suppression

Hydraulic and pneumatic systems are an integral part of most machines. The plug supplied is often not enough to meet the standards many applications require. Suppression is necessary for the machines functionality and a LED vital for fault-finding and maintenance.

Advantage:

- Simple plug-on mounting without any wiring
- Suitable adapter for all standard valves
- Protects the control system using the optimal network
- LED in yellow
- Adapter polarity safe for all voltages

Self wireable and pre-wired valve connector with LED and suppression see chapter 1

For contactors



For ABB-contactors

page 3.2.7



For AEG-contactors

page 3.2.8



For Moeller-contactors

from page 3.2.9



For SIEMENS-contactors

from page 3.2.12

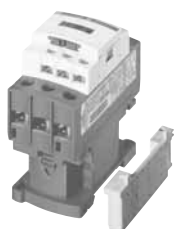

For Telemecanique-contactors

page 3.2.16



Universal suppressor module

from page 3.2.17

For motors, mounting directly at the motor



RC 3 U

Mounting universal or directly at the terminal box.

page 3.2.19



RC 3 R

Mounting at the terminal box.

page 3.2.20



RC 3 ST

Motor connector plug with integrated suppression and prewired cable.

page 3.2.21

For motors, mounting at the control panel



RC 3 BUR

Mounting directly in contactors.

page 3.2.22



HRC 3 AS

Space safety on DIN-rail mounting.

page 3.2.23



RC 3 RT

For Siemens SIRIUS contactor.

page 3.2.23

EMC suppressors for valve



VBS

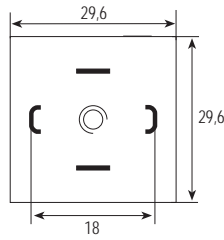

Form A EN 175301-803 (ISO 4400)

Contact form 18 mm, square
2 springs for PE-contact

page 3.2.24



DAB

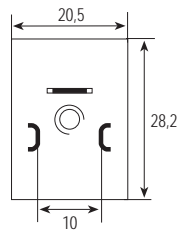

Form B EN 175301-803 (ISO 6952)

Contact form 10 mm, narrow
2 springs for PE-contact

page 3.2.25



LBS



PBS

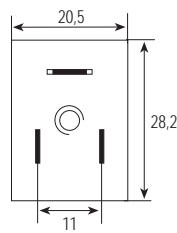

Form BI Industrial Standard

Contact form 11 mm, narrow
for plug with PE at cable entry

page 3.2.24 and 3.2.25



MVK

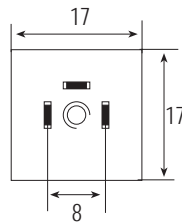

Form C EN 175301-803 (ISO 6952)

Contact form 8.0 mm
2 springs for PE-contact

page 3.2.26



MVT

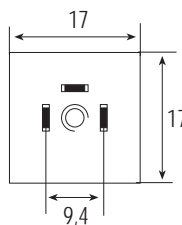

Form CI Industrial Standard

Contact form 9.4 mm
2 springs for PE-contact

page 3.2.26

Suppressors for contactors



Product group BBC

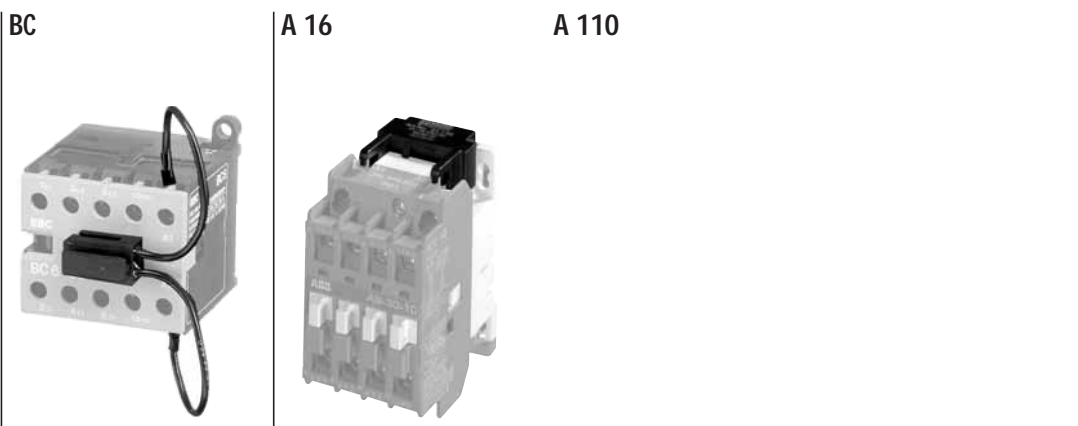

Circuit diagram

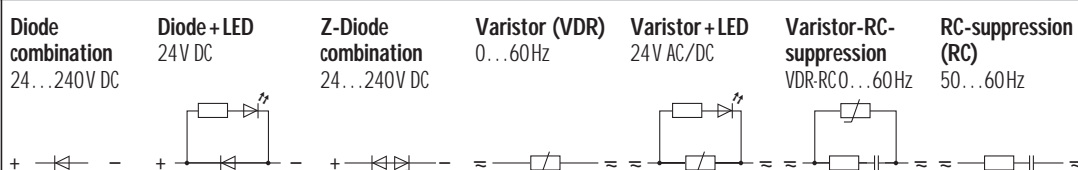

Appropriate contactors

B 6, BC 6, VB 6, KC 6	A 9...A 16	A 26...A 110
-----------------------	------------	--------------

Ordering data

Voltage	Suppression	approvals	Art.-No.	approvals	Art.-No.	approvals	Art.-No.
24 ... 240 V DC	Diode			UL + CSA	26440		
24 V DC	Diode + LED						
	Diode/Z-Diode						
24 V AC/DC	VDR	UL + CSA	26277	UL + CSA	26442		
	VDR + LED						
	RC			UL + CSA	21170		
48 V DC	Diode/Z-Diode						
48 V AC/DC	VDR	UL + CSA	26278				
	RC						
110 V AC/DC	VDR			UL + CSA	26444		
	VDR + LED						
	VDR-RC						
	RC			UL + CSA	21172	UL + CSA	21173
230 V AC/DC	VDR	UL + CSA	26079	UL + CSA	26446		
	VDR + LED						
	VDR-RC						
	VDR-RC + LED						
	RC			UL + CSA	21172	UL + CSA	21173
	RC						
400 V AC/DC	VDR						
	RC						
415 V AC/DC	RC						

Technical data

Damping factor	~ 1.5 x U _N
Temperature range	-20...+70 °C
Material	flame retardant plastic to UL 94
Connection wires	self-securing fork terminal ends plug contact

Dimensions



Notes

For other types, please inquire.

EMC suppressors

Suppressors for contactors

AEG

AS



A0



AD



Circuit diagram

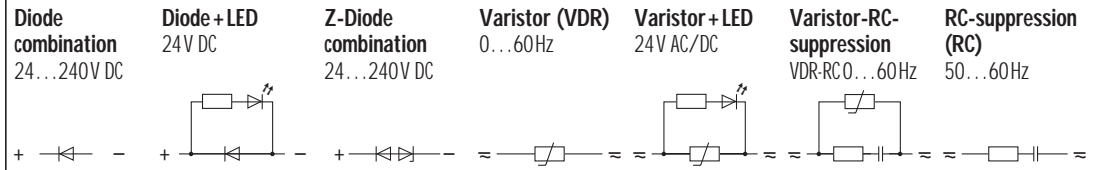

Appropriate contactors

LS 07, LS 4...LS 37, SH 04, SH 4, SH 08; SH 10	LS 02K, LS 05K LS 4K...LS 18K	LS 22K...LS 55K
---	----------------------------------	-----------------

Ordering data		Art.-No.	Art.-No.	Art.-No.
Voltage	Suppression	approvals	approvals	approvals
24 ...240 V DC	Diode	UL + CSA	CSA	
24 V DC	Diode + LED			
	Diode/Z-Diode		CSA	26073
24 V AC/DC	VDR	UL + CSA	UL + CSA	CSA
	VDR + LED			
	RC			
48 V DC	Diode/Z-Diode			
48 V AC/DC	VDR	UL + CSA	UL + CSA	CSA
	RC			UL + CSA
110 V AC/DC	VDR	UL + CSA	UL + CSA	CSA
	VDR + LED			
	VDR-RC			
	RC			
230 V AC/DC	VDR	UL + CSA	UL + CSA	CSA
	VDR + LED			
	VDR-RC	UL + CSA		
	VDR-RC + LED			
	RC	UL + CSA	UL + CSA	UL + CSA
	RC			
400 V AC/DC	VDR			
	RC		UL + CSA	UL + CSA
	RC			

Technical data

Damping factor	~ 1.5 x U _N
Temperature range	-20...+70 °C
Material	flame retardant plastic to UL 94
Connection wires	self-securing fork terminal ends

Dimensions

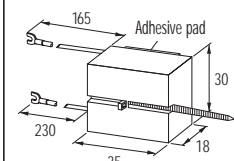
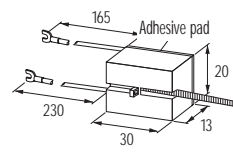
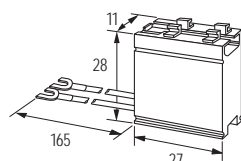

Notes

For other types, please inquire.

Suppressors for contactors



DIL E



B DIL



K DIL

Circuit diagram

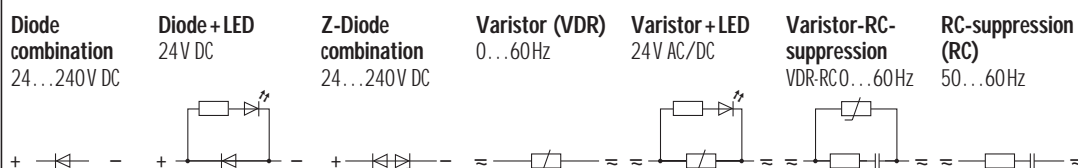

Appropriate contactors

DIL E...	DIL E...C	DIL 3 - 4...M DIL 3 H, DIL 4 H	DIL 0 - 2...M DIL R...
----------	-----------	-----------------------------------	---------------------------

Ordering data

Art.-No.	Art.-No.	Art.-No.	Art.-No.
----------	----------	----------	----------

Voltage	Suppression	approvals	Art.-No.	approvals	Art.-No.	approvals	Art.-No.	approvals	Art.-No.
24 ... 240 V DC	Diode							UL + CSA	26080
24 V DC	Diode + LED							UL + CSA	26081
	Diode/Z-Diode							UL + CSA	26170
24 V AC/DC	VDR	UL + CSA	26116			UL + CSA	26082	UL + CSA	26170
	VDR + LED								21026
	RC								
48 V DC	Diode/Z-Diode								
48 V AC/DC	VDR							UL + CSA	26171
	RC								
110 V AC/DC	VDR								
	VDR + LED								
	VDR-RC								
	RC	CSA	21054	UL + CSA	21056	UL + CSA	21073	UL + CSA	21028
230 V AC/DC	VDR	UL + CSA	26086	UL + CSA	26119	UL + CSA	26022	UL + CSA	26173
	VDR + LED								
	VDR-RC								
	VDR-RC + LED								
	RC	CSA	21054	UL + CSA	21056			UL + CSA	21028
	RC					UL + CSA	21073		
400 V AC/DC	VDR								
	RC								
	RC								

Technical data

Damping factor	~ 1.5 x U _N
Temperature range	-20...+70 °C
Material	flame retardant plastic to UL 94
Connection wires	ferrule ends for spring clamp terminals

Dimensions

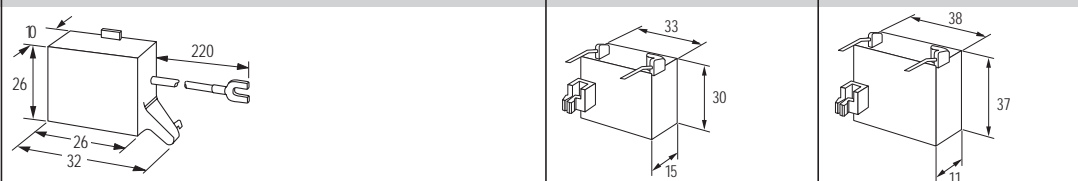

Notes

For other types, please inquire.

Suppressors for contactors



X-Start



Circuit diagram



Appropriate contactors

DIL M7...15 DIL MP20, DIL A	DIL M17...32	DIL M40...95
--------------------------------	--------------	--------------

Ordering data

Voltage	Suppression	approvals	Art.-No.	approvals	Art.-No.	approvals	Art.-No.
24 ...240 V DC	Diode						
24 V DC	Diode + LED						
	Diode/Z-Diode						
24 V AC/DC	VDR						
	VDR + LED	UL + CSA	26013	UL + CSA	26015		
	RC						
48 V DC	Diode/Z-Diode						
48 V AC	VDR + LED	UL + CSA	26013	UL + CSA	26015		
	RC						
110 V AC/DC	VDR						
	VDR + LED	UL + CSA	26014				
	VDR-RC						
	RC	UL + CSA	20007	UL + CSA	20008	UL + CSA	26009
230 V AC/DC	VDR						
	VDR + LED	UL + CSA	26014				
	VDR-RC						
	VDR-RC + LED						
	RC	UL + CSA	20007	UL + CSA	20008	UL + CSA	20009
	RC						
400 V AC/DC	VDR						
	RC						
	RC						

Technical data

Damping factor	~ 1.5 x U _N
Temperature range	-20...+70 °C
Material	flame retardant plastic to UL 94
Connection wires	plug contact

Dimensions

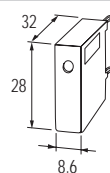

Notes

LED indicator for 24 V DC without suppression available on request.

Suppressors for contactors



U3



SO 1



RC-BUG 2



Circuit diagram

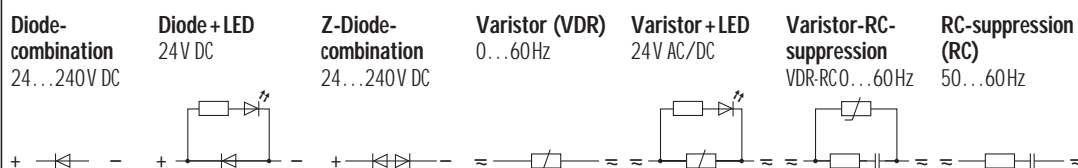

Appropriate contactors

DIL 6 (A) M, 6 H DIL 8 (A) M, 8 H, 10 M, 10 H	DIL R · G DIL R...	DIL 6 (A) M, 6 H DIL 8 (A) M, 8 H, 10 M, 10 H
--	-----------------------	--

Ordering data

		Art.-No.		Art.-No.	Art.-No.
Voltage	Suppression	approvals	approvals	approvals	
24 ... 240 V DC	Diode		UL + CSA	26051	
24 V DC	Diode + LED				
	Diode/Z-Diode		UL + CSA	26284	
24 V AC/DC	VDR		UL + CSA	26315	
	VDR + LED				
	RC		UL + CSA	22050	CSA 26612
48 V DC	Diode/Z-Diode		UL + CSA	26051	
48 V AC/DC	VDR				
	RC		UL + CSA	22050	CSA 26612
110 V AC/DC	VDR				
	VDR + LED				
	VDR-RC				
	RC		UL + CSA	22051	CSA 26613
230 V AC/DC	VDR		UL + CSA	26317	
	VDR + LED				
	VDR-RC				
	VDR-RC + LED				
	RC	UL + CSA 20067	UL + CSA	22052	CSA 26614
	RC		UL + CSA	22054	
400 V AC/DC	VDR				
	RC		UL + CSA	22054	
	RC				

Technical data

Damping factor	~ 1.5 x U _N
Temperature range	-20...+70 °C
Material	flame retardant plastic to UL 94
Connection wires	self-securing fork terminal ends

Dimensions

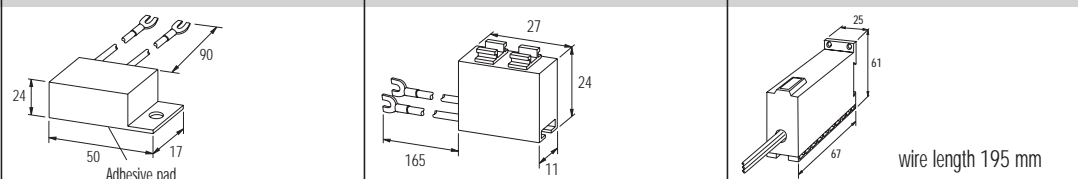

Notes

For other types, please inquire.

Suppressors for contactors

SIEMENS

S 00



S 0



Circuit diagram

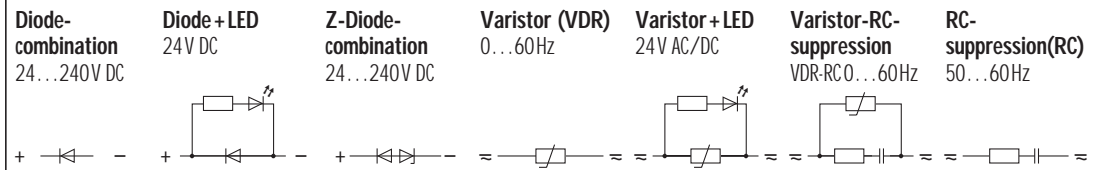

Appropriate contactors

3 RH 1/11, 3 RT 1/3 RH 1
3 RT 1/10.15...10.17

3 RT 10.24/25/26

Ordering data

Art.-No.

Art.-No.

Voltage	Suppression	approvals	Art.-No.	approvals	Art.-No.
24 ...240 V DC	Diode/Z-Diode	UL + CSA	26500	UL + CSA	26520
	Diode/Z-Diode			UL + CSA	¹⁾ 26528
24 V DC	Diode + LED	UL + CSA	26501		
	Diode + Z-Diode + LED				
24 V AC/DC	Diode/Z-Diode	UL + CSA	26502		
	VDR	UL + CSA	26503	UL + CSA	26524
	VDR + LED	UL + CSA	26504		
110 V AC/DC	RC	UL + CSA	21200	UL + CSA	21210
	VDR				
	VDR + LED				
	VDR-RC				
230 V AC/DC	RC	UL + CSA	21201		
	VDR	UL + CSA	26507	UL + CSA	26526
	VDR + LED	UL + CSA	26508		
	VDR-RC				
	VDR-RC + LED				
400 V AC/DC	RC	UL + CSA	21202	UL + CSA	21212
	VDR				

Technical data

Damping factor	~ 1.5 x U _N
Temperature range	-20...+70 °C
Material	flame retardant plastic to UL 94
Connection wires	plug contact

Dimensions

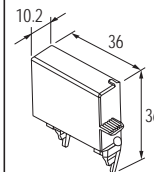
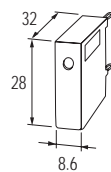

Notes

For other types, please inquire.
¹⁾ Mounts on the underside of the contactor.

Suppressors for contactors

SIEMENS

S 2



S 3



S 6 - S 12



Circuit diagram

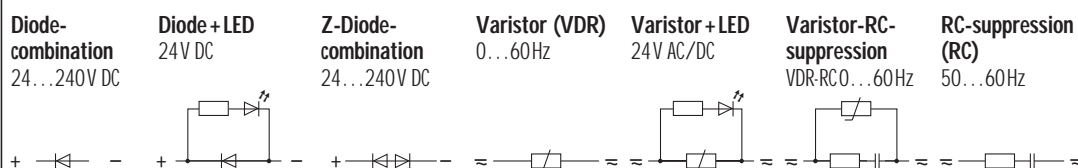

Appropriate contactors

3 RT 1.3/1.4

3 RT 1.5/6/7

Ordering data

Voltage		Suppression	Art.-No.	Art.-No.	Art.-No.
24 ... 240 V DC	Diode	approvals		UL + CSA	26521
	Diode + LED				
24 V DC	Diode + Z-Diode + LED				
	Diode/Z-Diode				
24 V AC/DC	VDR			UL + CSA	26524
	VDR + LED				
	RC	UL + CSA	21215		21220
48 V DC	Diode/Z-Diode				
48 V AC/DC	VDR				
	RC				21220
110 V AC/DC	VDR				
	VDR + LED				
	VDR-RC				
	RC				21221
230 V AC/DC	VDR			UL + CSA	26526
	VDR + LED				
	VDR-RC				
	VDR-RC + LED				
	RC	UL + CSA	21217		21222
400 V AC/DC	VDR				

Technical data

Damping factor	~ 1.5 x U _N
Temperature range	-20...+70 °C
Material	flame retardant plastic to UL 94
Connection wires	plug contact

Dimensions

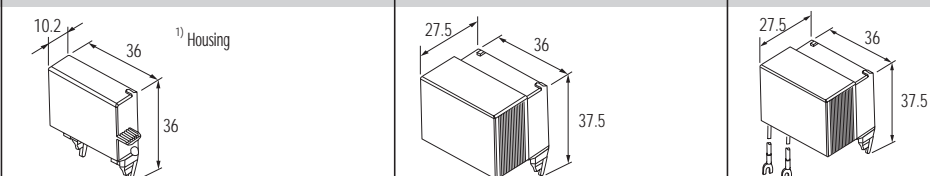

Notes

For other types, please inquire.

Suppressors for contactors

SIEMENS

SO 4

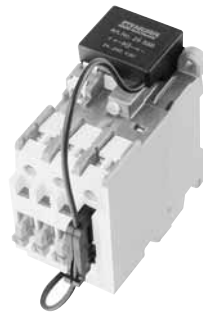

SO 1



3 TF/L-3 TF



Circuit diagram



Appropriate contactors

3 TH 3/4 3 TF 30...35, 3 TF 40...45	3 TH 3/4/8, 3 TF 30...45 3 TB 40...3 TB 44	3 TH 2, 3 TF 2 3 TH 20, 3 TF 20
--	---	------------------------------------

Ordering data		Art.-No.		Art.-No.	Art.-No.
Voltage	Suppression	approvals	approvals	approvals	
24 ...240 V DC	Diode		UL + CSA	26283	UL + CSA 26036
24 V DC	Diode + LED				UL + CSA 26530
	Diode + Z-Diode + LED				
	Diode/Z-Diode		UL + CSA	26051	UL + CSA 26034
24 V AC/DC	VDR	CSA 26576	UL + CSA	26315	UL + CSA 26037
	VDR + LED				UL + CSA 26531
	RC + VDR		UL + CSA	22050	UL + CSA 26328
48 V DC	Diode/Z-Diode				
48 V AC/DC	VDR	CSA 26576			UL + CSA 26038
	RC		UL + CSA	22051	
110 V AC/DC	VDR				
	VDR + LED				
	VDR-RC				
	RC	CSA 26571	UL + CSA	22051	
230 V AC/DC	VDR	CSA 26578	UL + CSA	26317	UL + CSA 26039
	VDR + LED				
	VDR-RC				UL + CSA 26331
	VDR-RC + LED				
	RC		UL + CSA	22052	
	RC		UL + CSA	22054	
400 V AC/DC	VDR				
	RC		UL + CSA	22054	

Technical data

Damping factor	~ 1.5 x U _N
Temperature range	-20...+70 °C
Material	flame retardant plastic to UL 94
Connection wires	self-securing fork terminal ends

Dimensions

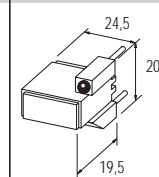
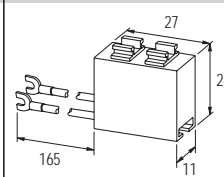
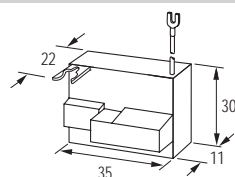

Notes

For other types, please inquire.

Suppressors for contactors

SIEMENS

U 3



H



AO



Circuit diagram

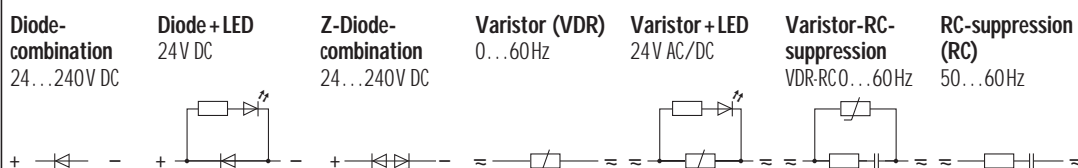

Appropriate contactors

3 TF 46...50, 3 TB 48...56 3 TC 48...56	3 TF 2, 3 TK 2 3 TF 30...33, 3 TF 40...43	3 TF 46...56, 3 TB 40...56 3 TK 48...56, 3 TC 48...56
--	--	--

Ordering data		Art.-No.	Art.-No.	Art.-No.
Voltage	Suppression	approvals	approvals	approvals
24 ... 240 V DC	Diode	26027	CSA	26097
	Diode + Z-Diode			
24 V DC	Diode/Z-Diode		CSA	26095
24 V AC/DC	VDR		UL + CSA	26090
	VDR + LED			
	RC			
48 V DC	Diode/Z-Diode			CSA
48 V AC/DC	VDR			
	RC		CSA	20100
110 V AC/DC	VDR		UL + CSA	26092
	VDR + LED			
	VDR-RC			
	RC	UL + CSA	20066	
230 V AC/DC	VDR	26673	UL + CSA	26093
	VDR + LED			
	VDR-RC			
	VDR-RC + LED			
	RC	UL + CSA	20067	CSA
	RC		CSA	20102
400 V AC/DC	VDR			
	RC			
	RC			

Technical data

Damping factor	~ 1.5 x U _N
Temperature range	-20...+70 °C
Material	flame retardant plastic to UL 94
Connection wires	self-securing fork terminal ends

Dimensions

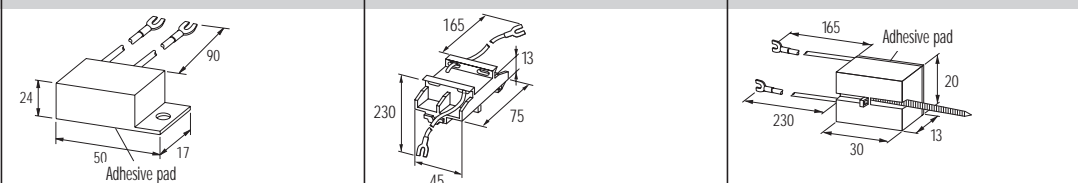

Notes

For other types, please inquire.

Suppressors for contactors



K



D



TeSys

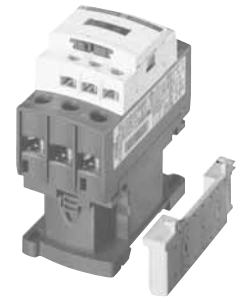

Circuit diagram



Appropriate contactors

CA 2-K...CA 4-K, LC...-K, LP...-K Series "k"	CA 2 DN, CA 3 DN Series "d" LC 1 D09...D32, LP 1 D0...D32	LC 1 D09...D38 LC 1 DT20, DT40, LC 2 D09...D38
---	--	---

Ordering data	Art.-No.	Art.-No.	Art.-No.
Voltage	approvals	approvals	approvals
24 ...240 V DC		26481	
24 V DC			26476
	26380		26477
24 V AC/DC		26487	
			21070
			21062
48 V DC			
48 V AC/DC			21070
			26479
110 V AC/DC			
	26384		21063
		26491	26478
230 V AC/DC			
	26384		
			21060
			21063
400 V AC/DC			

Technical data

Damping factor	~ 1.5 x U _N
Temperature range	-20...+70 °C
Material	flame retardant plastic to UL 94

Connection wires	plug contact	self-securing fork terminal ends	plug contact
------------------	--------------	----------------------------------	--------------

Dimensions

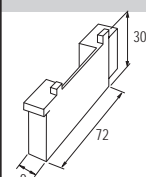
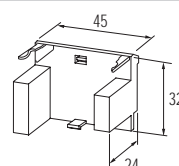
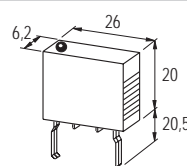

Notes

For other types, please inquire.

Suppressors

Universal

AO



AD



CF



Circuit diagram

Diode-combination
24...240 V DC

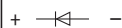

Z-Diode-combination

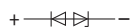

Varistor (VDR)
0...60 Hz

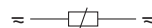

Varistor-RC-suppression
VDR-RC 0...60 Hz

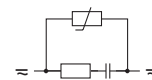

RC-suppression (RC)
50...60 Hz



Appropriate contactors

universal

universal

universal

Ordering data

Ordering data		Art.-No.	Art.-No.	Art.-No.	sugg. coil valves		
Voltage	Suppression	approvals	approvals	approvals	AO	AD	CF
Max. 240 V DC	Diode	CSA 26001			15 W		
24 V DC	Z-Diode	CSA 26120	CSA 26073		25 W	75 W	
24 V AC/DC	VDR	UL + CSA 26180	CSA 26720		50 VA/W	200 VA/W	
	RC			CSA 20680			15 VA
48 V DC	Z-Diode						
48 V AC/DC	VDR	UL + CSA 26181	CSA 26721		70 VA/W	200 VA/W	
	RC	UL + CSA 20001	UL + CSA 20013		10 VA	15 VA	20 VA
110 V AC/DC	VDR	UL + CSA 26182	CSA 26722		100 VA/W	200 VA/W	
	VDR-RC						
	RC						
230 V AC/DC	VDR	UL + CSA 26183	CSA 26723		200 VA/W	200 VA/W	
	VDR	UL + CSA ¹⁾ 26184			200 VA/W		
	RC		CSA 20014	CSA 20682	10 VA	25 VA	15 VA
	RC	UL + CSA 20002	UL + CSA 20010	CSA 20683	20 VA	75 VA	20 VA
400 V AC/DC	RC		UL + CSA 20011	CSA ²⁾ 20687		100 VA	50 VA
	VDR		CSA 26724			200 VA/W	
	RC	UL + CSA 20004	UL + CSA 20012	CSA 20688	15 VA	20 VA	10 VA

Technical data

Damping factor ~ 1.5

Temperature range -20...+70 °C

Material flame retardant plastic to UL 94

Connection wires self-securing fork terminal ends

self-securing fork terminal ends

flexible connection wires

Dimensions

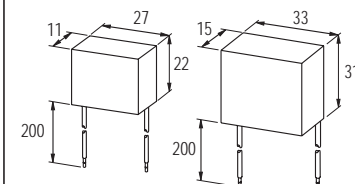
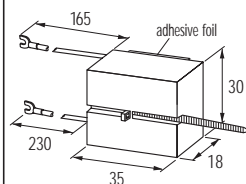
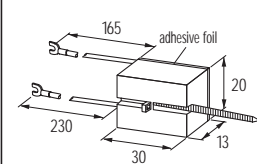

Notes

For other types, please inquire.

¹⁾ up to 300 V AC/DC

Suppressors for motors

Mounting methods:

- on the motor terminal box
- inside the motor terminal box
- inside the distribution box
- on 35 mm DIN-rail to EN 60715

RC 3 U

with M16 x 1.5 screw



RC 3 BU



RC 3 BUG



Circuit diagram

RC-suppression

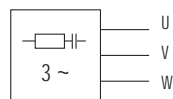

Varistor-suppression (VDR)

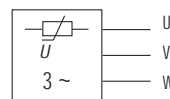

6-wire

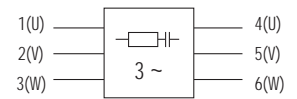

Ordering data

Ordering data		Art.-No.	Art.-No.	Art.-No.			
Voltage	Motor rating	suppression	suppression	suppression			
	3 x 400 V AC	4 kW	RC	23022	RC/UL	23050	RC
	4 kW			VDR/UL	23115	VDR	23100
	4 kW			VDR/UL	23115	RC	
	7.5 kW			VDR/UL	23115	RC	23104
	10 kW	RC	23011	VDR/UL	23118	RC	23106
	10 kW	RC/6-wire	23043				
	20 kW			VDR/UL	23118		
3 x 575 V AC	4 kW			RC/UL	23050		
	7.5 kW	RC/UL	23035			RC	23104
	20 kW					VDR	23102
	45 kW					RC/6-wire	¹⁾ 23103
3 x 690 V AC	4 kW			RC/UL	23056	RC	23104
	7.5 kW					RC	23104
	20 kW					VDR	23105

Technical data

Frequency	for RC: 50...60 Hz		for VDR: 10...400 Hz
Material	flame retardant plastic to UL 94		
Potting compound	2-component epoxy		
Temperature range	-20...+60 °C		
Connection method	approx. 500 mm PVC cable	approx. 200 mm single core	approx. 500 mm single core
	3 x 0.75 mm ² resp. 6 x 0.75 mm ²	0.5 mm ²	1 mm ²
		self-securing M4 fork terminal ends	
Dimensions (H x B x T)	41 x 41 x 41 mm	40 x 15 x 43 mm	61 x 25 x 92 mm

Dimension drawing

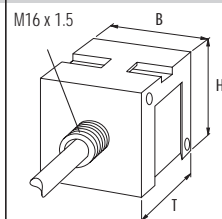

For DIN-rail mounting use
2 x Art.-No. 20900 adapter feet.

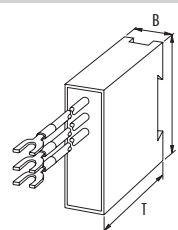

For DIN-rail mounting use
1 x Art.-No. 20900 adapter feet.

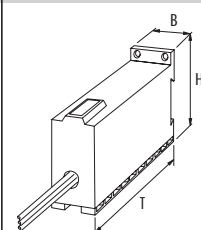

For DIN-rail mounting use
2 x Art.-No. 20900 adapter feet.

Notes

For other voltages, frequencies and motor ratings, please inquire. Do not use RC motor suppressors on variable frequency drives.
¹⁾ 1 x Art.-No. 23103 required per phase.

Suppressors for motors

Mounting methods:

- with M16 x 1.5 and M20 x 1.5
- on motor terminal box with plug connectors

RC 3 R

with M16 x 1.5 screw



RC 3 R

with M16 x 1.5 screw



RC 3 RG

with M20 x 1.5 screw



Circuit diagram

RC-suppression

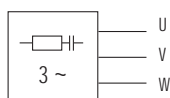

Varistor-suppression (VDR)

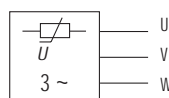

6-wire

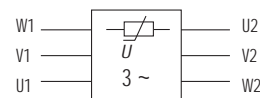

Ordering data

Ordering data		Art.-No.	Art.-No.	Art.-No.
Voltage 3 x 400 V AC	Motor rating	suppression	suppression	suppression
	4 kW	VDR/UL	23170	VDR
	4 kW			23175
	4 kW			
	7.5 kW	VDR	23171	
	10 kW			VDR
3 x 575 V AC	4 kW	VDR/UL	23172	RC/UL
	7.5 kW	VDR/UL	23173	
	10 kW			VDR
	20 kW			VDR/6-wire
	20 kW			VDR
	20 kW			VDR/6-wire
3 x 690 V AC	7.5 kW	VDR	¹⁾ 23174	
	20 kW			VDR/6-wire
	20 kW			²⁾ 23148
	20 kW			VDR

Technical data

Frequency	for RC: 50...60 Hz		for VDR: 10...400 Hz
Material	flame retardant plastic to UL 94		
Potting compound	2-component epoxy		
Temperature range	-20...+60 °C		
Connection method	approx. 100 mm single core 0.5 mm ²		approx. 150 mm single core 1 mm ²
Ring terminals	isolated M6	isolated M4	isolated M6
Dimensions	40 mm, Ø 24.5 mm		44 mm, Ø 39 mm

Dimension drawing

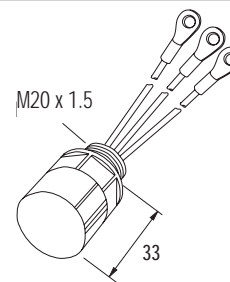
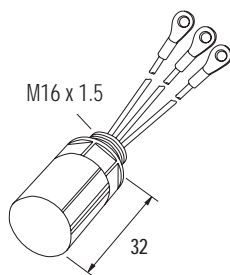

Notes

For other voltages, frequencies, motor ratings, resp. cable/wire lengths please inquire.
Do not use RC motor suppressors on variable frequency drives. ¹⁾ wire diameter 1.5 mm² ²⁾ to max. 660 V AC

Suppressors for motors

Mounting methods:

- on motor terminal box with plug connectors

RC 3 ST

connector with cable and integrated motor suppression
cable outlet at the back



RC 3 ST

connector with cable and integrated motor suppression



Circuit diagram

Varistor-suppression (star)

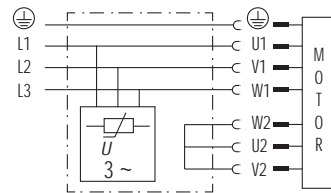

Varistor-suppression (delta)

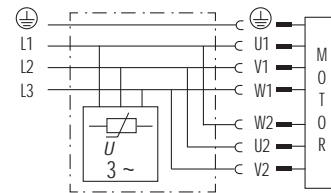

Ordering data

Voltage	Motor rating	Cable length	suppression	Art.-No.	Art.-No.
max.	5.5 kW	5 m	VDR/star	236139	VDR/star
3 x 575 V AC	5.5 kW	6 m	VDR/star	236140	
	5.5 kW	8 m	VDR/star	236141	
	5.5 kW	10 m	VDR/star	236142	VDR/star
	5.5 kW	6 m	VDR/delta	236143	236149

Technical data

Frequency	10...400 Hz				
Plug connector	female, 10-pol. + PE				
Housing	aluminium pressure diecasting				
Temperature range	-20...+60 °C				
Connection method	PUR cable black, 4 x 1.5 mm ² ; numbered wires, halogen free		PUR cable black, 4 x 1.5 mm ² ; numbered wires, DESINA® conform		
Dimensions	see dimension drawing				

Dimension drawing

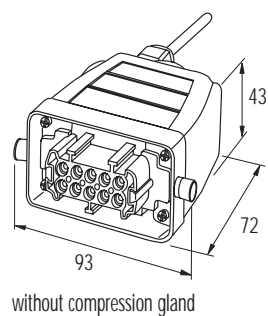

Notes

Suppressors for motors

Mounting methods:

- on 35 mm DIN-rail to EN 60715
- bolted together, stacked
- DIN-rail mounted under the control gear

HRC 3



HRC 3 K



RC 3 BUR

connects onto Siemens SIRIUS contactors
3 RT 10



Circuit diagram

RC-suppression

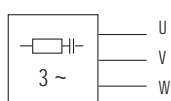

Varistor-suppression (VDR)

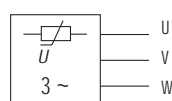

6-wire

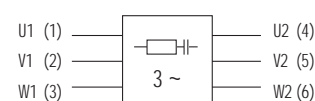

Ordering data		Art.-No.	Art.-No.	Art.-No.
Voltage 3 x 400 V AC	Motor rating	suppression	suppression	suppression
	4 kW	RC/UL	²⁾ 23000	RC
	4 kW	RC/UL	23004	RC
	4 kW	RC/UL	¹⁾ 233463	
	5.5 kW			RC/UL
	7.5 kW			
	10 kW	RC/UL	23002	RC
	20 kW	RC/6-wire/UL	23009	
3 x 575 V AC	20 kW	VDR/UL	23015	
	5.5 kW			RC/UL
	7.5 kW	RC/UL	23006	RC
	7.5 kW	RC/UL	¹⁾ 230563	
	10 kW	VDR/UL	23016	
	20 kW			RC
3 x 660 V AC	10 kW	RC	23017	

Technical data

Frequency	for RC: 50...60 Hz, for VDR: 10...400 Hz		
Material	flame retardant plastic to UL 94		
Potting compound	2-component epoxy		
Temperature range	-20...+60 °C		
Connection method	250 mm single core (Art.-No. 23000: 300 mm) 0.5 mm ² (Art.-No. 23000: 1.5 mm ²) self-securing M4 fork terminal ends	3-pole terminal 2 x (0.75...2.5 mm ²) M4	wire (solid core) 1.5 mm ²
Dimensions (H x B x T)	75 x 45 x 42 mm	75 x 45 x 42 mm	40 x 15 x 43 mm

Dimension drawing

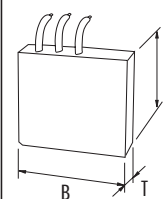
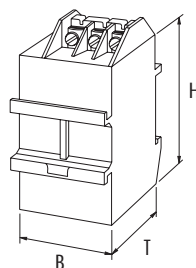
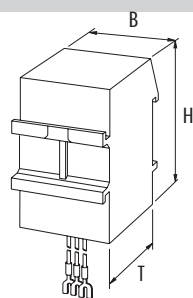

Notes

For other voltages, frequencies and motor ratings, please inquire. Do not use RC motor suppressors on variable frequency drives.

¹⁾ Has ferrule ends. ²⁾ Max. nominal voltage 3 x 500 V AC +10 %

Suppressors for motors

Mounting methods:

- DIN-rail mounted under the control gear
- fixes onto contactors
- available with integrated coil suppression

HRC 3 AS



RC 3 RT

connects onto Siemens SIRIUS contactors
3 RT 10



Circuit diagram

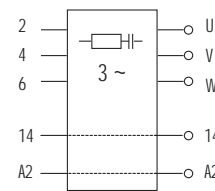
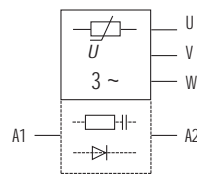
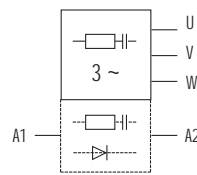

Appropriate contactors

Motor contactors up to 5.5 kW from Siemens, Moeller, Sprecher + Schuh etc.

Siemens 3 RT 10

Ordering data

Voltage		Motor rating	suppression	Art.-No.	suppression	Art.-No.	suppression	Art.-No.
3 x 400 V AC	5.5 kW	RC	23160	VDR	23163	RC/UL + CSA	¹⁾ 23180	
		RC + Diode	23151	VDR + Diode	23155			
3 x 575 V AC	5.5 kW	RC	23161	VDR	23164	RC/UL + CSA	¹⁾ 23181	
		RC + Diode	23153	VDR + Diode	23157			

Technical data

Suppression coil	for RC: 230 V AC/20 VA, for Diode: 24...230 V DC/36 W
Frequency	for RC: 50...60 Hz, for VDR: 10...400 Hz
Material	flame retardant plastic to UL 94
Temperature range	-20...+60 °C
Connection method	ferrules, load side securely fixed
Dimensions (H x B x T)	75 x 45 x max. 100 mm (fully stretched)

Dimension drawing

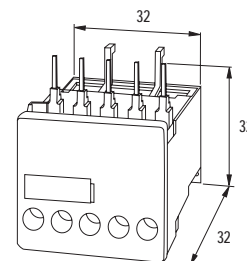
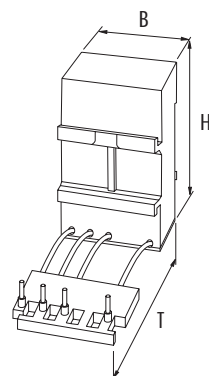

Notes

For other voltages, frequencies and motor ratings, please inquire. Do not use RC motor suppressors on variable frequency drives.

Suppressor for valves

with LED
with suppressor and LED

VBS
form A
pin spacing 18 mm
EN 175301-803 (ISO 4400)



LBS
industrial standard
pin spacing 11 mm



Circuit diagram

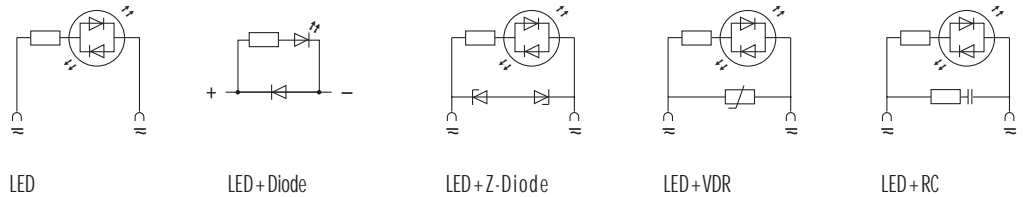

Ordering data		Art.-No.	Art.-No.	Switch off- delay time [ms]	Switch off- voltage peak [V]	Valve hold-on rating [W/VA]
Voltage	Suppression					
³⁾ 24 V DC	LED + Diode	¹⁾ 3124021	3124221	200	1	50
24 V AC/DC	LED	¹⁾ 3124015	3124215	–	–	50
	LED + Z-Diode	¹⁾ 3124033	3124233	20	55	100
	LED + VDR	¹⁾ 3124048	3124248	15	45	50
	LED + RC	3124068		20	105	10
	LED + RC			20	70	20
48 V AC/DC	LED	¹⁾ 3124017		–	–	50
	LED + VDR	¹⁾ 3124052		10	75	100
	LED + RC	²⁾ 3124071		20	90	30
110 V AC/DC	LED	3124018		–	–	50
	LED + VDR	3124046		10	235	100
	LED + RC	3124070		20	250	10
	LED + RC	²⁾ 3124072		20	250	25
230 V AC/DC	LED	3124016	3124216	–	–	50
	LED + VDR	3124049	3124249	15	360	100
	LED + RC	3124063	3124263	20	300	10
	LED + RC	²⁾ 3124064		20	300	25

Technical data

Supply indicator	yellow LED
Contact material	silvered bronze
Protection	IP65 when fully mounted
Material	black polyamide, flame retardant, temp. resist. up to 130 °C
Temperature range	-20...+60 °C

Dimension drawing

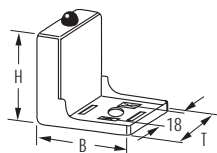

Housing H x B x T: 37 x 45 x 30 mm
¹⁾ Housing H x B x T: 37 x 39 x 30 mm
²⁾ Housing H x B x T: 37 x 53 x 33 mm

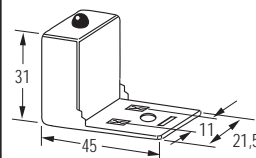

Note PIN arrangement (PE at cable outlet of connector)
 180° version on request

Notes

Do not use plug gasket when fitting adapter. Other LED colors on request.
 For double valves the VA 2 series is suitable (please inquire). ³⁾ Polarity dependent

Suppressor for valves

with LED
with suppressor and LED

PBS

industrial standard
pin spacing 11 mm



DAB

form B
pin spacing 10 mm
EN 175301-803 (ISO 6952)



Circuit diagram

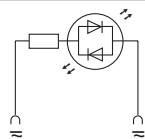

LED

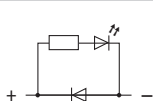

LED+Diode

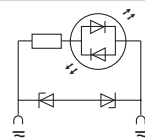

LED+Z-Diode

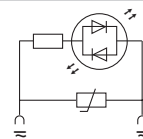

LED+VDR

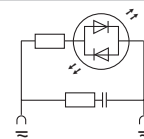

LED+RC

Ordering data

Voltage		Suppression	Art.-No.	Art.-No.	Switch off delay time [ms]	Switch off voltage peak [V]	Valve hold-on rating [W/VA]
1) 24 V DC	LED + Diode		3124121	3124871	200	1	50
	LED		3124115	3124875	–	–	50
	LED + Z-Diode		3124133	3124873	20	55	100
	LED + VDR		3124148		15	45	50
	LED + RC		3124169		20	70	20
110 V AC/DC	LED + VDR		3124146		10	235	100
	LED + RC		3124170		20	250	10
230 V AC/DC	LED		3124116		–	–	50
	LED + VDR		3124149		15	360	100
	LED + RC		3124163		20	300	10

Technical data

Supply indicator	yellow LED
Contact material	silvered bronze
Protection	IP65 when fully mounted
Material	black polyamide, flame retardant, temp. resist. up to 130 °C
Temperature range	-20...+60 °C

Dimension drawing

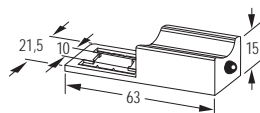
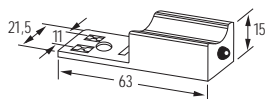

Note PIN arrangement (PE at cable outlet of connector) 180° version on request.

Suitable for 0 and 180° installation

Notes

Do not use plug gasket when fitting adapter. Other LED colors on request.
RT-angle housing version with 10 mm pin spacing (DAR/DARU), on request. ¹⁾ Polarity dependent

Suppressor for valves

with LED
with suppressor and LED

MVT
industrial standard
pin spacing 9.4 mm



MVK
form C
pin spacing 8.0 mm
EN 175301-803 (ISO 6952)



Circuit diagram

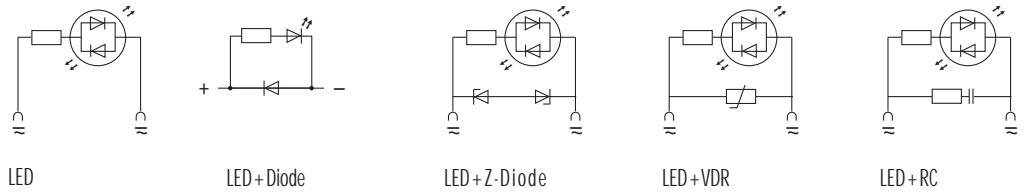

Ordering data

		Art.-No.	Art.-No.	Switch off delay time [ms]	Switch off voltage peak [V]	Valve hold-on rating [W/VA]
Voltage	Suppression					
	24 V AC/DC	LED	3124815	3124811	–	50
		LED + Z-Diode	3124832	3124833	20	100
48 V AC/DC	LED + Z-Diode		3124835	20	75	100

Technical data

Supply indicator	yellow LED
Contact material	silvered bronze
Protection	IP65 when fully mounted
Material	black polyamide, flame retardant, temp. resist. up to 130 °C
Temperature range	-20...+60 °C

Dimension drawing

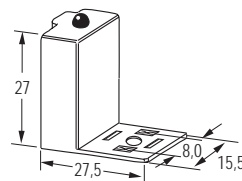
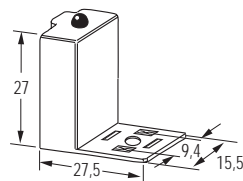

Notes

Do not use plug gasket when fitting adapter. Other LED colors on request.
¹⁾ Polarity dependent